

Anti-Diabetic Therapeutic Medicinal Plant Identification Using Deep Fused Discriminant Subspace Ensemble (D²SE)

N. Sasikaladevi¹, S. Pradeepa², A. Revathi³, S. Vimal^{4*}, Gaurav Dhiman^{5,6,7*}

¹ Department of Computer Science and Engineering, SASTRA Deemed University, Thanjavur-613 401, Tamil Nadu (India)

² Department of Information Technology, SASTRA Deemed University, Thanjavur -613 401, Tamil Nadu (India)

³ Department of Electrical and Computer Engineering, SASTRA Deemed University, Thanjavur -613 401, Tamil Nadu (India)

⁴ Department of Artificial Intelligence & Data Science, Sri Eshwar College of Engineering, Coimbatore, Tamil Nadu (India)

⁵ Department of Electrical and Computer Engineering, Lebanese American University, Byblos (Lebanon)

⁶ Centre of Research Impact and Outcome, Chitkara University Institute of Engineering and Technology, Chitkara University, Punjab (India)

⁷ MEU Research Unit, Middle East University, Amman (Jordan)

* Corresponding author: svimalphd@gmail.com (S.Vimal), gdhiman0001@gmail.com (G. Dhiman)

Received 29 March 2023 | Accepted 1 September 2023 | Early Access 27 May 2024



ABSTRACT

About 422 million people worldwide have diabetes, the majority living in low-and middle-income countries, and 1.5 million deaths are directly attributed to diabetes each year. According to the Botanical Survey of India, India is home to more than 8,000 species of medicinal plants. The natural medications with antidiabetic activity are widely formulated because they have better compatibility with human body, are easily available and have less side effects. They may act as an alternative source of antidiabetic agents. The fused deep neural network (DNN) model with Discriminant Subspace Ensemble is designed to identify the diabetic plants from VNPlant200 data set. Here, the deep features are extracted using DenseNet201 and the matrix-based discriminant analysis is adopted to learn the discriminative feature subspace for classification. To further improve the performance of discriminative subspace, a nearest neighbors technique is used to produce a subspace ensemble for final diabetic therapeutic medicinal plant image classification. The developed model attained the highest accuracy of 97.5% which is better compared to other state of art algorithms. Finally, the model is integrated into a mobile app for robust classification of anti-diabetic therapeutic medicinal plant with real field images.

KEYWORDS

Classification, Deep Learning, Diabetic Plant Identification, Discriminant Subspace Ensemble, Internet Of Things (IoT).

DOI: 10.9781/ijimai.2024.05.003

I. INTRODUCTION

IN 2021, approximately 537 million adults (20-79 years) are living with diabetes. The total number of people living with diabetes is projected to rise to 643 million by 2030 and 783 million by 2045.3 in 4 adults with diabetes live in low- and middle-income countries. Almost 1 in 2 (240 million) adults living with diabetes are undiagnosed. Diabetes caused 6.7 million deaths. Diabetes caused at least USD 966 billion dollars in health expenditure – 9% of total spending on adults. More than 1.2 million children and adolescents (0-19 years) are living with type 1 diabetes. 1 in 6 live births (21 million) are affected by diabetes during pregnancy. 541 million adults are at increased risk of developing type 2 diabetes. Antidiabetic herbal formulations are considered to be more effective for treatment of diabetes. A high number of plants and plant

products have been scientifically tested and reported to possess anti diabetic activity [1].

Antidiabetic herbal formulations are considered to be more effective for treatment of diabetes. The global worsening of morbidity and mortality from diabetes [2] [3] justifies the need for more diversified research for new therapies. Throughout human history, medicinal plants have been used for the prevention and treatment of both human and animal diseases [4] [5]. Medicinal plants have been recognized as a stable source for drug discovery since ancient times [6] [7] and The World Health Organization has reported an increased patronage of natural and medicinal plant drug products¹.

¹ <https://www.who.int/health-topics/diabetes>

Please cite this article as:

N. Sasikaladevi, A. Revathi, S. Pradeepa, S.Vimal, G. Dhiman. Anti-Diabetic Therapeutic Medicinal Plant Identification Using Deep Fused Discriminant Subspace Ensemble (D²SE), International Journal of Interactive Multimedia and Artificial Intelligence, (2024), <http://dx.doi.org/10.9781/ijimai.2024.05.003>

Many modern drugs are obtained from medicinal plants and further purified or optimized using structure-activity relationship-driven drug design and pharmacokinetic parameters [8] [9]. Evidence-based application of phytochemicals from plants in the management of diseases has received wide acceptability [10]. For example, several reports of medicinal plants with anticancer activities have been published [11] [12]. Ethnopharmacological surveys of plants and phytochemicals with antihypertensive activities [13] have been well documented.

There is also substantial literature of their utility in treatment of other chronic diseases such as Alzheimer's [14], depressive disorders [15], Parkinson's disease [16] and diabetes [17]. Various plants and plant parts have been investigated for their hypoglycemic activities as potential medicine in the treatment of diabetes mellitus [18]. By way of examples, phytochemicals from the fruit of *Momordica charantia* (bitter lemon) have been extensively studied for antidiabetic effects [19].

The roots of *Zingiber officinale* (ginger) exert antidiabetic and hypolipidemic effects on streptozotocin-induced diabetic rats [20]. *Bidens pilosa* has been shown to reduce fasting blood glucose level and hemoglobin A1c (HbA1c) in clinical trials [15]; three variants of *B. pilosa* were shown to possess anti-diabetic properties [21]. The hydroethanolic extract of the seed of *Parinaricuratellifolia* reduces plasma glucose levels and low-density lipoproteins in diabetic rats [22].

The blood sugar reducing effects of *Gymnemasylvestre* popularly known as 'gurmar' ('sugar destroyer') has been widely studied. Phytochemical constituents of *Glycyrrhizauralensis* (licorice) have been found to exhibit profound antidiabetic properties in experimental animals [23]. While some studies do consider the potential molecular or cellular mechanisms of the antidiabetic effects [24], others focus on potential properties such as antioxidant [5] and anti-obesity [25] effects without direct discussion of mechanism.

Modern medicine is massively produced for medical treatment, but many countries are now opting for traditional medicine due to the limitation of synthetic drugs in controlling and curing chronic diseases (WHO, 1999). Traditional medicines are used extensively in the pharmaceutical industry, where a quarter of the globally prescribed drug is extracted from medicinal plants. This is due to the benefits of medicinal plants that offer substantially lower adverse reactions and are more cost-effective than synthetic drugs. Furthermore, bioactive compounds such as phenolic, carotenoids, anthocyanin, and tocopherols that can be extracted from medicinal plants [26] serve as antioxidants, anti-allergenic, anti-inflammatory, antibacterial, and also anti-hepatotoxic.

Nonetheless, the task of manually identifying medicinal plants is complicated and time-consuming, similar to other plant recognition, due to the unavailability of expert opinions [23] [24] [25]. Inspired by these problems, researchers introduced numerous automatic plant or leaf recognition systems, most of which utilized Machine learning and deep learning approaches.

Deep learning methods play an essential role in plant leaf classifications. Deep learning methods are based on Convolutional Neural Networks (CNN), which comprise deep feature extractors. When the system is developed to classify medicinal plants, that system should be trained by a large dataset, including noisy images. The primary goal of the recognition system is to interpret the leaf images with high accuracy compared to the manual task. In a highly densely populated country like India, there is a lack of manual experts. Hence, there is a demand to accurately develop an AI-based tool for medicinal plants.

This paper is organized as follows. Section II reviews the existing machine learning algorithms and deep learning methods for medicinal plant classification that are categorized according to their performance. Section III describes the proposed D2SE model

for medicinal plant leaf classification and elucidates the details of the medicinal plants which are used in this work. Section IV elaborates on the proposed system's experimental work and performance, and Section V concludes the paper.

II. RELATED WORKS

CNN-based medicinal plant identification is proposed [27] and attained an accuracy of 88.26%. Amuthalingeswaran et al. [28] proposed Deep Neural Network (DNN) model for the medicinal leaf classification for four medicinal plants such as *Catharanthus Roseus*, *Tephrosia Purpurea*, *Phyllanthus amarus*, and *Abutilon Indicum*. Putri et al. [29] proposed the CNN model for Indonesian medicinal plant leaf identification. Dileep et al. [30] applied the Alexnet neural network model to medicinal plant leaf for deep feature extraction, and then the Support Vector Machine (SVM) classifier is applied for classification. ResNet-based medicinal plant classification is proposed [31] Liu et al. [32] applied GoogleNet for the classification of Chinese herbal plant classification. Muneer et al. [33] applied the SVM and DNN classifier to Malaysian herbal leaf data. Mukherjee et al. [34] proposed a CNN model with binary particle swarm optimization based hyperparameter tuning method for medicinal plant classification. The Multiorgan-based classification model is proposed by Lee et al. [35]. All the diagnosis methods are tabulated in Table I.

Deep learning models for the classification of diabetic medicinal plants are limited. Furthermore, Table I shows that most of the current models yield low accuracy, which is insufficient for robust identification. Hence, there is a demand for developing a robust deep learning model for the classification of diabetic therapeutic medicinal plant.

III. PROPOSED D²SE FRAMEWORK

The deep learning phase of D²SE has three primary stages: data augmentation, feature extraction using Densenet201 and Matrix-Based Discriminative Feature Subspace Learning. Fig. 1 shows proposed D²SE framework for Anti-diabetic therapeutic medicinal plant identification.

A. Data Collection and Preprocessing

Applications of image processing and computer vision techniques for identifying medicinal plants are critical, as many of them are under extinction, per the International Union for Conservation of Nature (IUCN) records. Hence, the digitization of valuable medicinal plants is crucial for the conservation of biodiversity. Studies reveal that building an intelligent system for recognizing medicinal herbs requires a decent size of the plant image dataset. Thus, diabetic related images of VNPlant-200 dataset are acquired from the National Institute of Medicinal Materials. They are labeled manually by botanists and technical expert. This dataset is more challenging and noisier than others because many leaves appear together in a single image and it also contains the background such as soil, treebark, flower, etc. Table II illustrates several image examples from diabetic class of VNPlant-200 dataset, with two versions of resolutions: 256X256 and 512X512 pixels.

This dataset is divided into different partitions for training and Validation. In order to perform hold-out Validation, a set of images is to be kept aside for training. Those unseen data are to be given to the model for perfect Validation. Hence, the dataset is divided into 70% for training and 30% for Validation. Table III shows the sample references for the medicinal plant available in the VNPlant 200 data set.

B. Feature Extraction Using Densenet201

Hyper-tuning of Deep transfer learning models (DTL) can improve results in classification problems [46]-[49]. Here, a Deep Transfer

TABLE I. STATE-OF-THE-ART METHODS FOR THE MEDICINAL PLANT CLASSIFICATION

Authors	Method used	Dataset	Performance	Drawback
(Quoc, 2020) [27]	VGG16, Resnet50, InceptionV3, DenseNet121, Xception and MobileNet	Vietnamese medicinal plant images	Accuracy of 88.26%	Low accuracy
(Amuthalingeswaran, 2019) [28]	Deep neural network	Private dataset with four plants	Accuracy 85%	Low accuracy and four-class classifier only
(Putri, 2021) [29]	CNN	Indonesian medicinal leaf dataset	Not given	Nonstandard analysis
(Dileep, 2019) [30]	Alexnet+SVM	Kerala medicinal plant leaf dataset	Accuracy 96.76%	Slow convergence
(Liu, 2021) [31]	Resnet	Grassland plant data set	Accuracy 96.8%	Nonstandard data division
(Liu, 2018) [32]	GoogleNet	Chinese herbal medicine	Accuracy 62.8%	Low accuracy
(Muneer,2020) [33]	SVM and DNN	Medical herbs in Malaysia	Accuracy with SVM: 74.63% Accuracy with DNN:93%	Low accuracy
(Mukherjee, 2021) [34]	CNN with hyperparameter tuning	Private dataset with Neem, Tulsi, and Kalmegh	Accuracy 99%	Nonstandard database. Limited class classification
(Tiwari, 2022) [36]	DNN	Private plant leaf dataset	Accuracy 97.67%	Nonstandard analysis
(Lee, 2018) [35]	CNN	Multiorgan dataset	Leaf: 76% Flower: 81%	Low precision
(Bhuiyan, 2021) [37]	CNN	Bangladesh medicinal plant	Accuracy of 84%	Low Accuracy
(Almazaydeh, 2022) [38]	R-CNN	Mendeley medicinal plant dataset	Accuracy of 95.7%	slow convergence

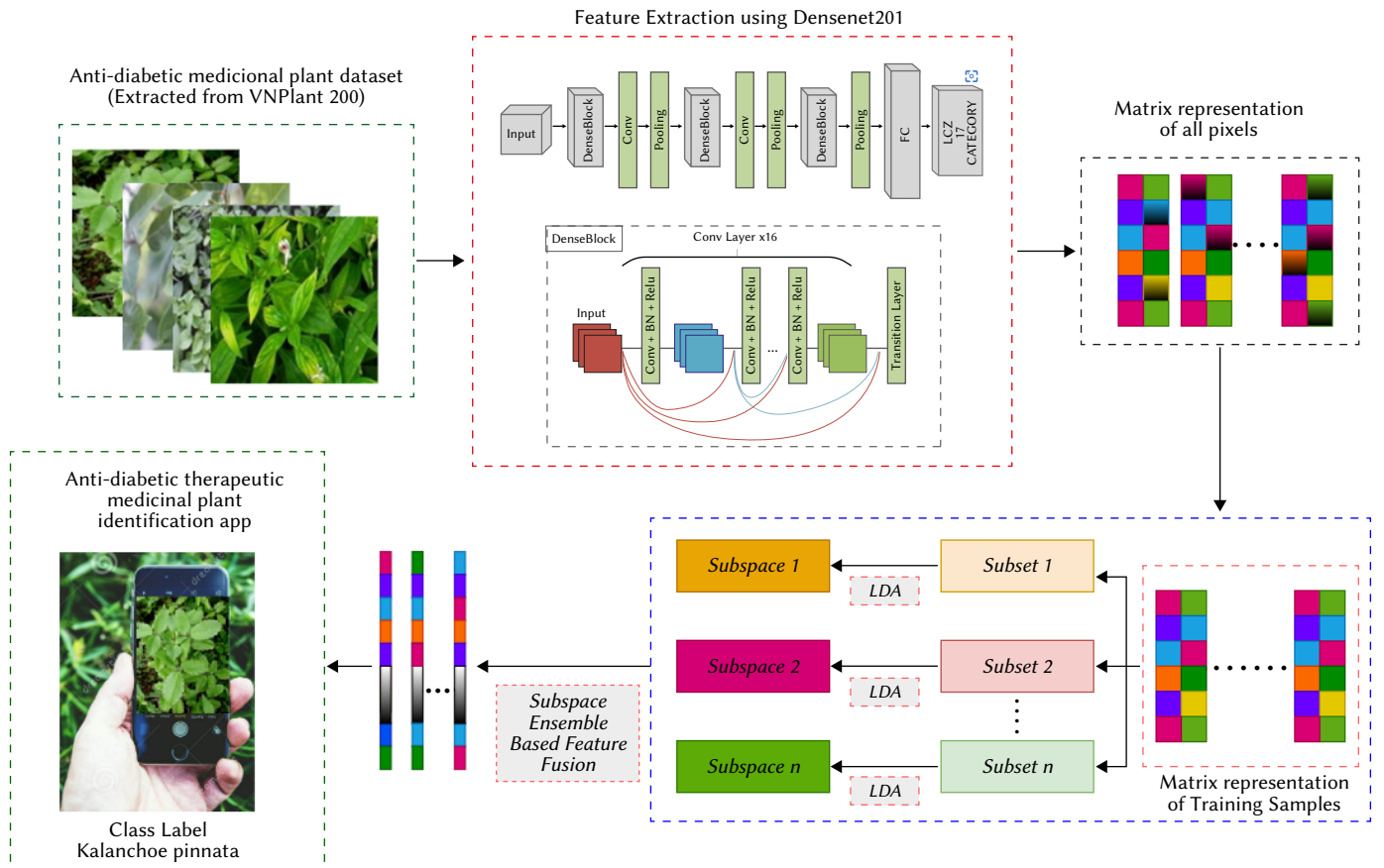
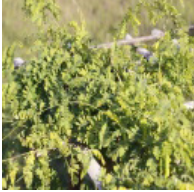
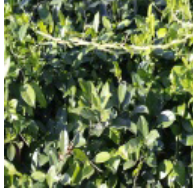



Fig. 1. Proposed D²SE framework for Anti-diabetic therapeutic medicinal plant identification.

TABLE II. D²SE – MEDICINAL PLANTS AND THEIR MEDICINAL VALUES

					
Abrus precatorius	Aloe vera	Andrographis paniculata	Caesalpinia sappan	Capsicum annum	Carica papaya
					
Catharanthus roseus	Celosia argentea	Centella asiatica	Coix lacryma-jobi	Costus speciosus	Curculigo orchioides
					
Euphorbia hirta	Ficus auriculata	Ficus racemosa	Glycosmis pentaphylla	Gymnema sylvestre	Holarrhenapubescens
					
Kalanchoe pinnata	Lawsonia inermis	Mangifera	Melastomamalabathricum	Mentha spicata	Mimosa pudica
					
Morinda citrifolia	Moringa oleifera	Morus alba	Nelumbo nucifera	Ocimum basilicum	Ocimum gratissimum
					
Ocimum sanctum	Psidium guajava	Senna alata	Tabernaemontana divaricata	Tamarindus indica	Zingiber officinale

Learning model with DenseNet201 is used for feature extraction by using its own learned weights on the Anti-diabetic medicinal plant dataset (Extracted from VNPlant 200). The DenseNet201 exploits the condensed network providing easy to train and highly parametrically efficient models due to the possibility of feature reuse by different layers which increases variation in the subsequent layer input and improves the performance. Fig. 2 shows the feature extraction techniques using DenseNet201.

The feature concatenation can be mathematically explained as in Equation (1).

$$Z^l = H_l([Z^0, Z^1, \dots, Z^{l-1}]) \quad (1)$$

Here, H_l is a non-linear transformation which can be defined as a composite function comprising of batch normalization (BN), followed by a rectified linear unit function (ReLU) and a Convolution of (3X3). $[Z^0, Z^1, \dots, Z^{l-1}]$ refers to the feature map concatenation corresponding to layer 0 to $l-1$ which are integrated in a single tensor for ease of implementation. For down-sampling purposes, dense blocks are created in the network architecture which are separated by layers called transition layers which consist of BN followed by 1×1 convolution layer and finally a 2×2 average pooling layer. DenseNet201 performs sufficiently well even with a smaller growth rate owing to its architecture where feature maps are considered as a global state of the network. Therefore, each successive layer has access to all feature maps of preceding layers. k feature maps are added to

TABLE III. SAMPLE REFERENCES FOR THE MEDICINAL PLANT AVAILABLE IN THE VNPLANT-200 DATA SET

Indian Medicinal Plant	Plant Part	Therapeutic use identifier	Reference
Abrusprecatorius	leaf	MESH:D003920 , UMLS:C0011849 , DOI:9351, ICD-11:5A14	(Kirtikar. 2012) [39]
Aloe vera	leaf	MESH:D003920 , UMLS:C0011849 , DOI:9351, ICD-11:5A14	(NISC, 2004) [40]
Andrographis paniculata	whole plant	MESH:D003920 , UMLS:C0011849 , DOI:9351, ICD-11:5A14	(Kirtikar. 2012) [39]
Caesalpinia sappan	wood	MESH:D003920 , UMLS:C0011849 , DOI:9351, ICD-11:5A14	(Kirtikar. 2012) [39]
Capsicum annum		MESH:D003920 , UMLS:C0011849 , DOI:9351, ICD-11:5A14	(Kirtikar. 2012) [39]
Carica papaya	Fruit, root, seed	MESH:D003920 , UMLS:C0011849 , DOI:9351, ICD-11:5A14	(NISC, 2004) [40]
Catharanthus roseus	Flower, leaf, plant exudate, root, whole plant	MESH:D003920 , UMLS:C0011849 , DOI:9351, ICD-11:5A14	(NISC, 2004) [40]
Celosia argentea	seed	MESH:D003920 , UMLS:C0011849 , DOI:9351, ICD-11:5A14	(Kirtikar. 2012) [39]
Centella asiatica		MESH:D003920 , UMLS:C0011849 , DOI:9351, ICD-11:5A14	(Sivarajan, 2017) [41]
Coixlacryma-jobi	Leaf, seed	MESH:D003920 , UMLS:C0011849 , DOI:9351, ICD-11:5A14	(Asolkar, 2010) [42]
Costusspeciosus		MESH:D003920 , UMLS:C0011849 , DOI:9351, ICD-11:5A14	(Sivarajan, 2017) [41]
Curculigoorchoides	Rhizome, root	MESH:D003920 , UMLS:C0011849 , DOI:9351, ICD-11:5A14	(Kirtikar. 2012) [39]
Euphorbia hirta	aerial part, flower, leaf	MESH:D003920 , UMLS:C0011849 , DOI:9351, ICD-11:5A14	(Kirtikar. 2012) [39]
Ficus auriculata	Fruit, leaf	MESH:D003920 , UMLS:C0011849 , DOI:9351, ICD-11:5A14	(Kirtikar. 2012) [39]
Ficus racemosa	Bark, fruit, leaf, plant exudate, root, seed, stem, whole plant	MESH:D003920 , UMLS:C0011849 , DOI:9351, ICD-11:5A14	(Kirtikar. 2012) [39] (NISC, 2004) (CSIR, 2010) [40] (Chopra, 2022) [43]
Glycosmis pentaphylla	leaf	MESH:D003920 , UMLS:C0011849 , DOI:9351, ICD-11:5A14	(Kirtikar. 2012) [39]
Gymnemasylvestre	Bark, fruit, leaf, root, shoot, stem, whole plant	MESH:D003920 , UMLS:C0011849 , DOI:9351, ICD-11:5A14	(Khare, 2008) (Chopra, 2022) [44] [43] (NISC, 2004) (Asolkar, 2010) [40] (CSIR, 2010) [45]
Holarrhenapubescens	Bark, leaf, root, seed,	MESH:D003920 , UMLS:C0011849 , DOI:9351, ICD-11:5A14	(Kirtikar. 2012) [39]
Kalanchoe pinnata	leaf	MESH:D003920 , UMLS:C0011849 , DOI:9351, ICD-11:5A14	(Khare, 2008) [44] (Asolkar, 2010) [42]
Lawsoniainermis	flower	MESH:D003920 , UMLS:C0011849 , DOI:9351, ICD-11:5A14	(Kirtikar. 2012) [39]
Mangifera	Bark, flower, fruit, leaf, seed	MESH:D003920 , UMLS:C0011849 , DOI:9351, ICD-11:5A14	(Khare, 2008) [44], (Kirtikar. 2012) [39] (NISC, 2004) [40]
Melastomamalabathricum	leaf	MESH:D003920 , UMLS:C0011849 , DOI:9351, ICD-11:5A14	(Kirtikar. 2012) [39]
Mentha Spicata	leaf	MESH:D003920 , UMLS:C0011849 , DOI:9351, ICD-11:5A14	(Kirtikar. 2012) [39]
Mimosa pudica	Leaf, root, whole plant	MESH:D003920 , UMLS:C0011849 , DOI:9351, ICD-11:5A14	(Kirtikar. 2012)[39]
Morindacitrifolia	fruit	MESH:D003920 , UMLS:C0011849 , DOI:9351, ICD-11:5A14	(Kirtikar. 2012) [39]
Moringa oleifera	aerial part, bark, fruit, leaf, seed	MESH:D003920 , UMLS:C0011849 , DOI:9351, ICD-11:5A14	(Kirtikar. 2012) [39]
Morus alba	leaf	MESH:D003920 , UMLS:C0011849 , DOI:9351, ICD-11:5A14	(Kirtikar. 2012) [39]
Nelumbo nucifera	Rhizome, seed, shoot	MESH:D003920 , UMLS:C0011849 , DOI:9351, ICD-11:5A14	(Kirtikar. 2012) [39]
Ocimumbasilicum		MESH:D003920 , UMLS:C0011849 , DOI:9351, ICD-11:5A14	(Kirtikar. 2012) [39]
Ocimumgratissimum	leaf	MESH:D003920 , UMLS:C0011849 , DOI:9351, ICD-11:5A14	(Kirtikar. 2012) [39]
Ocimum sanctum	aerial part, leaf, seed	MESH:D003920 , UMLS:C0011849 , DOI:9351, ICD-11:5A14	(Kirtikar. 2012) [39]
Psidium guajava	leaf	MESH:D003920 , UMLS:C0011849 , DOI:9351, ICD-11:5A14	(Khare, 2008) [44]
Senna alata	flower	MESH:D003920 , UMLS:C0011849 , DOI:9351, ICD-11:5A14	(Kirtikar. 2012) [39]
Tabernaemontanadivaricata	leaf	MESH:D003920 , UMLS:C0011849 , DOI:9351, ICD-11:5A14	(Kirtikar. 2012) [39]
Tamarindus indica	seed	MESH:D003920 , UMLS:C0011849 , DOI:9351, ICD-11:5A14	(Kirtikar. 2012) (Warrier, 2022) [46]
Zingiber officinale		MESH:D003920 , UMLS:C0011849 , DOI:9351, ICD-11:5A14	(Sivarajan, 2017) [41]

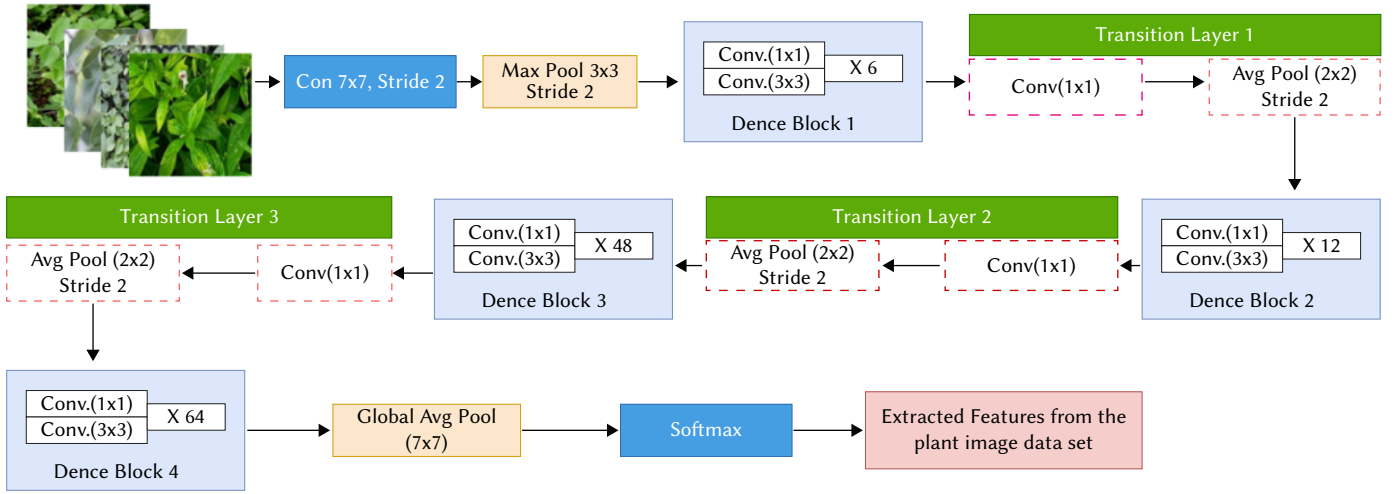

Fig. 2. Feature Extraction using DenseNet201.

the global state by each layer where the total number of input feature maps at l th layers (FM) l is defined in Equation (2).

$$(FM)^l = k^0 + k(l-1) \quad (2)$$

Here, the channels in the input layer is given by k^0 . To improve computational efficiency, a 1x1 convolution layer is introduced preceding every 3x3 convolution layer which decreases the number of input feature maps which are typically more than the output feature maps k . The feature extraction network followed by sigmoid activation is used in the classical DenseNet201 architecture. Each neuron in the fully connected dense layer is fully connected to each neuron in previous layer. It can be mathematically explained by a fully connected layer 1 whose input 2D feature map is expanded to a 1D feature vector as (3)-(5).

$$t^{l-1} = \text{Bernoulli}(p) \quad (3)$$

$$x^{l-1} = t^{l-1} * c^{l-1} \quad (4)$$

$$x^l = f(w^k x^{l-1} + o^l) \quad (5)$$

Here, Bernoulli function randomly generates a vector t^{l-1} obeying the 0-1 distribution with a specified probability. The vector dimension is c^{l-1} . The first two layers of the full connection layer use the dropout strategy to randomly block certain neurons according to a specified probability, which effectively prevents the over-fitting phenomena in the deep networks. w^l and o^l define the weighting and offset parameters of the fully connected layer respectively. The sigmoid activation function is to convert the non-normalized outputs to binary outputs as 0 or 1. The sigmoid function can be defined in Equation (6).

$$y = \frac{1}{1 + e^{-(\sum w_i x_i)}} \quad (6)$$

where y is the output of the neuron. w_i and x_i represent the weights and inputs, respectively.

C. Matrix-Based Discriminative Feature Subspace Learning

The extracted features are represented by $X \in R^{m \times n}$. The Latent Dirichlet Allocation (LDA) is used to reduce the redundant information in this feature matrix and improve the discriminant ability of feature representation. LDA map X into a new subspace, in which the intraclass scatter is minimized and the interclass scatter is maximized.

Assume that $M = [\alpha_1, \alpha_2, \dots, \alpha_j] \in R^{m \times j}$ and $G = [v_1, v_2, \dots, v_c] \in R^{n \times c}$ are two transformation matrices. Then, the projection of X onto the $(f \times c)$ dimensional space $M \otimes G$ can be represented in Equation (7).

$$Z = M^T X G \quad (7)$$

Suppose there are P training pixels and L different classes to be classified. The j^{th} training pixel is X_j , where $j \in \{1, 2, \dots, P\}$.

$F_W^G = \sum_{i=1}^L \sum_{x_k \in \pi_i} (X_k - \mu_i) G G^T (X_k - \mu_i)^T$ and μ_i denote the mean of all training pixels and training pixels in class π_i , $i \in \{1, 2, \dots, L\}$ respectively. P_i is the number of training pixels in class π_i . To get the optimal projection matrices, we maximize the ratio of the interclass scatter matrix and the intraclass scatter matrix for LDA. Fortunately, the total scatter of the projected pixels can be measured by the trace of their covariance matrix. Therefore, the objective function can be described in Equation (8).

$$J = \frac{F_B}{F_W} \quad (8)$$

where F_B denotes the interclass scatter matrix, and F_W denotes the intraclass scatter matrix with the following definitions:

$$F_B = \text{tr}(\sum_{i=1}^L P_i (\mu_i - \mu)(\mu_i - \mu)^T) \quad (9)$$

$$F_W = \text{tr}(\sum_{i=1}^L \sum_{z_k \in \pi_i} (z_k - \mu_i)(z_k - \mu_i)^T) \quad (10)$$

$$\mu_i = \frac{1}{P_i} \sum Z_k = \frac{1}{P_i} \sum Z = M^T X_k G \quad (11)$$

The same as in [33], we utilize an iterative algorithm to optimize M and G . In particular, for a fixed G , (8) can be rewritten in the following form (Refer Equation (12)-(14)):

$$J = \frac{M^T F_B^G M}{M^T F_W^G M} \quad (12)$$

Where,

$$F_B^G = \sum_{i=1}^L P_i (\mu_i - \mu) G G^T (\mu_i - \mu)^T \quad (13)$$

$$F_W^G = \sum_{i=1}^L \sum_{x_k \in \pi_i} (X_k - \mu_i) G G^T (X_k - \mu_i)^T \quad (14)$$

Hence, the optimal solution of M consists of r eigenvectors corresponding to r maximal eigenvalues by computing an eigen decomposition on $(F_W^G)^{-1} F_B^G$. Subsequently, the optimal solution of G can be obtained when M is fixed. The whole process will iterate until a predefined convergence condition is arrived.

D. Learning Subspace Ensemble With Random Sampling

Ensemble learning has been proved to be an efficient technique to improve the stability and accuracy of single weak classifier by training several different classifiers and combining their decisions.

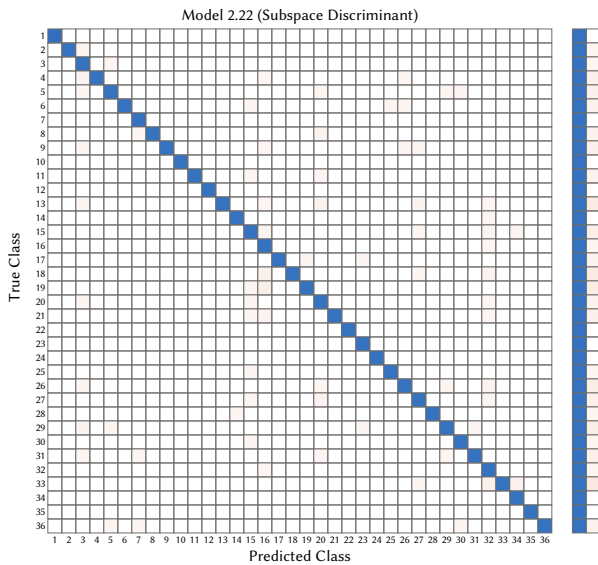
Fig. 3. D²SE- Confusion Matrix.

The core idea is to randomly sample a few training subsets from the original training set repeatedly with replacement. In this situation, the intraclass scatter matrix will be dominated by the majority classes. Thus, the dimensionality reduced subspace can preserve the structure information of majority classes while ignoring that of the minority classes, resulting in a decreased performance for subsequent classification. Here, we propose a random sampling- based subspace ensemble method for features extracted from the LDA. On one hand, motivated by bagging methods, random sampling repeatedly derives a few different training subsets, leading to diverse discriminant subspaces. These subspaces ensemble will improve the classification capacity. The bagging algorithm has been used to construct nearest neighbors ensemble for diabetic plant classification, and the experiments suggest that an optimized ensemble method could lead to improved results.

Fig. 1 shows the detailed flowchart of the proposed method. Suppose that we have a training set X , and X_j represents the j^{th} training pixel. First, n training subsets are randomly sampled from X with replacement according to a certain proportion (e.g., 80%), and $X(i)$, $i \in \{1, 2, \dots, n\}$ denotes the i^{th} training subset. Then, for every subset $X(i)$, LDA is used to learn the optimal transformations $M(i)$ and $G(i)$ as discussed in Section III-C. Thereafter, for every couple $M(i)$ and $G(i)$, the projection matrix

$Z_j^{(i)}$ of X_j can be achieved according to (1). Therefore, we can obtain n projection matrices $\{Z_j^{(1)}, Z_j^{(2)}, \dots, Z_j^{(n)}\}$. Finally, all of these matrices are reshaped to vectors, respectively. In feature fusion phase, we concatenate these vectors into one stacked vector, and Principal Component Analysis (PCA) is used to reduce the redundancy in the vector.

IV. RESULTS

This section focuses on the experimental setup for validating the proposed model, followed by a performance analysis. Finally, the proposed D²SE is compared with other state-of-the-art deep learning models for classifying anti diabetic medicinal plants.

A. Experimental Setup and Evaluation

The proposed transfer learning model is implemented in MATLAB 2020b with GPU NVIDIA and 16GB RAM Workstation computer. VNPlant-200 is accepted as the benchmark data set by the researchers. The proposed model is trained and tested with the same dataset.

The Evaluation of the proposed model is based on two phases: training and Validation. The acceptable tuned hyperparameters are established to train the proposed transfer learning model, and the overall performance is validated. The first standard metric for evaluating the proposed model is based on confusion matrix, including sensitivity, specificity, precision, and accuracy. The confusion matrix is shown in Fig. 3 and the Parallel Co-ordinate Plot for Ensemble Subspace discriminant is depicted in Fig. 4.

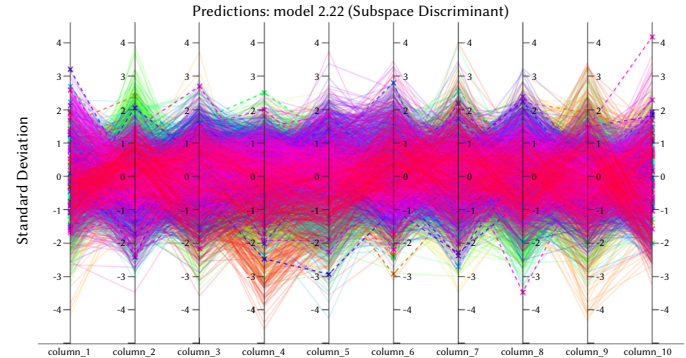

Fig. 4. Parallel Co-ordinate Plot – Ensemble Subspace discriminant.

Then, the proposed model is further validated based on the Receiver Operating Characteristic Curve (ROC), a graphical representation that illustrates the classification capacity of the system. This curve is constructed by plotting True Positive Rate (TRP) against False Positive Rate (FPR). Another metric derived from the ROC plot is the Area Under the Curve (AUC), which measures the model's overall quality. Fig. 5 shows the ROC plot with the AUC of at most 1 for all the TIM plants.

B. Comparison With Other Medicinal Plant Classification Models

This section presents the performance comparison of the proposed model with other state-of-the-art techniques for medicinal plant classification. As the proposed model is trained and validated with the VNPlant-200 dataset, the training and validation performance of the proposed model is compared with the other models based on the same Mendeley dataset. The proposed model is also based on Inception network but with a residual connections-based deep transfer learning network. Incorporating the residual connection is better for training performance and validation performance. Table IV portrays the classification performance with machine learning algorithms. Table V shows the Classification Performance with Discriminant Analysis.

Table VI shows that the proposed model reaches the maximum training accuracy of 97.5 in the 20th iteration and the equivalent training time and prediction speed of the proposed model–D2SE. Table VII shows the results of testing samples with the label and its accuracy based on the number of learners and subspace dimension. Researchers have recently proposed several other methods to identify medicinal plants from leaf images. The proposed model is compared with all the existing deep learning-based classification systems for medicinal with the same data set. Table VIII shows that the proposed deep transfer learning model provides the highest validation accuracy of 97.5% compared to all other models. It shows that the proposed model outperforms the other existing state-of-the-art deep learning models for identifying medicinal plants. Moreover, the proposed model D2SE is designed as Mobile application.

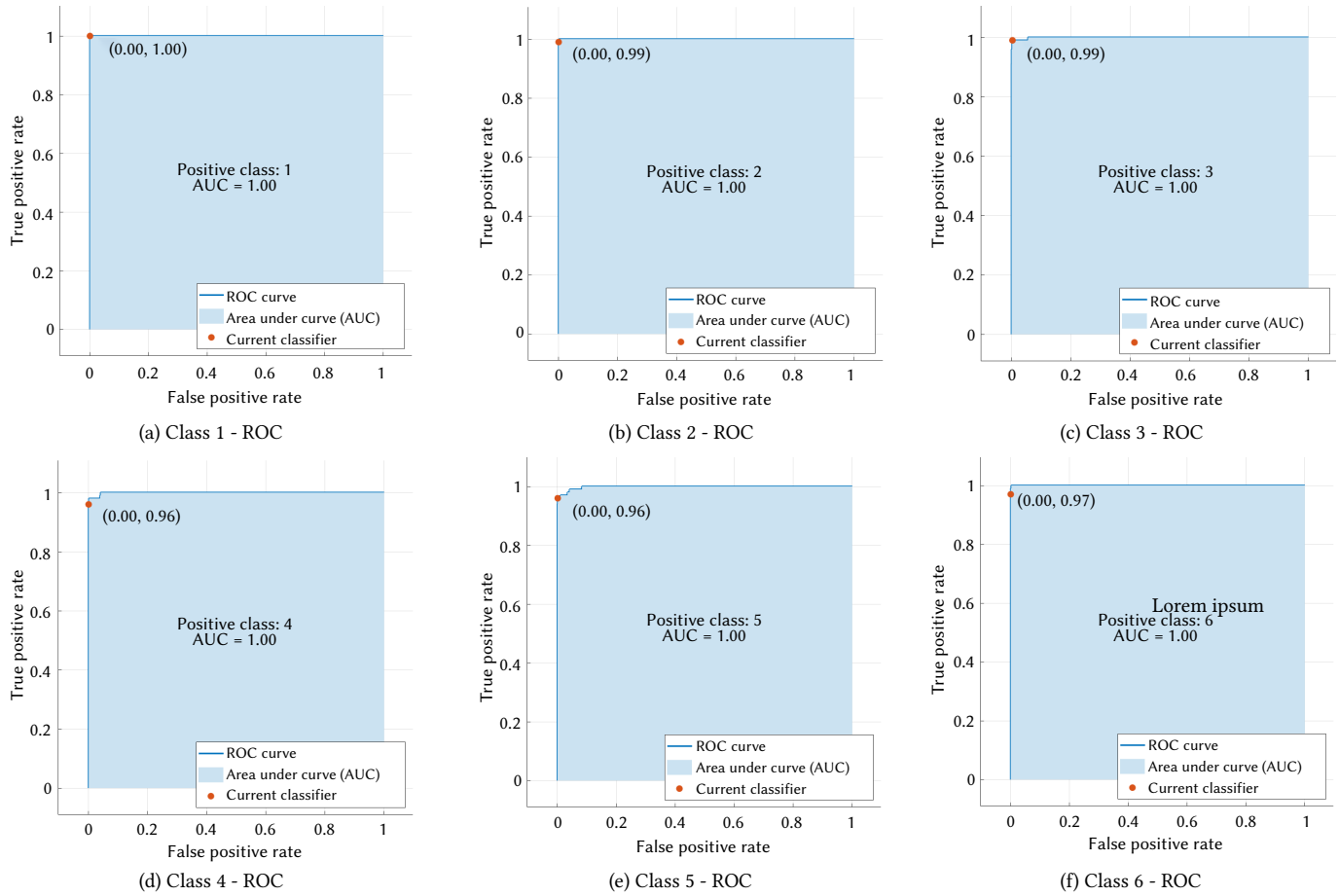

Fig. 5. D²SE- RoC plot.

TABLE IV. DENSE FEATURES – CLASSIFICATION PERFORMANCE WITH MACHINE LEARNING MODELS

Sl. No.	Classifier	Total Misclassification Cost	Training time (Secs)	Prediction speed	Accuracy
1.	Linear SVM	201	393.78	76/sec	94.4
2.	Quadratic SVM	173	2334.8	20/sec	95.2
3.	Cubic SVM	170	670.98	33/sec	95.3
4.	Fine Gaussian SVM	3123	889.36	23/sec	13.3
5.	Medium Gaussian SVM	340	664.8	30/sec	90.6
6.	Coarse Gaussian SVM	367	682.75	29/sec	89.8
7.	Fine KNN	189	109.33	250/sec	94.8
8.	Medium KNN	326	63.083	240/sec	90.9
9.	Coarse KNN	792	64.776	240/sec	78.0
10.	Cosine KNN	288	60.143	270/sec	92.0
11.	Cubic KNN	337	1869.4	8/sec	90.6
12.	Weighted KNN	265	68.86	260/sec	92.6
13.	Gaussian Naïve Bayes	507	143.82	1000/sec	85.9
14.	Kernel Naïve Bayes	592	61979	3/sec	93.6
15	Liner Discriminant Analysis	166	118.45	160/sec	95.4

TABLE V. DENSE FEATURES – CLASSIFICATION PERFORMANCE WITH DISCRIMINANT ANALYSIS

Sl. No.	Discriminant	Covariance structure	Training time	Prediction speed	Accuracy
1.	Linear Discriminant Analysis	Full	118.45	160/sec	95.4
2.	Linear Discriminant Analysis	Diagonal	35.893	1400/sec	83.5
3.	Quadratic Discriminant Analysis	Full	NA	NA	NA
4.	Quadratic Discriminant Analysis	Diagonal	15.628	1300/sec	85.9
5.	Optimized Discriminant	Full	1765.3	200/sec	95.4
6.	Ensemble Subspace Discriminant	Full	872.65	21/sec	97.5

TABLE VI. DENSE FEATURES – CLASSIFICATION PERFORMANCE WITH DISCRIMINANT ANALYSIS BASED ON TRAINING TIME AND PREDICTION SPEED

Sl. No.	Discriminant	Training time	Prediction speed	Accuracy
1.	Ensemble Boosted Trees	2144.2	3500/sec	48.4
2.	Ensemble Bagged Trees	87.521	3500/sec	89.3
3.	Ensemble Subspace Discriminant	832.26	22/sec	97.5

TABLE VII. DENSE FEATURES – CLASSIFICATION PERFORMANCE WITH ENSEMBLE SUBSPACE DISCRIMINANT

Sl. No.	Discriminant	No. of learners	Subspace Dimension	Learner type	Accuracy
1.	Ensemble Subspace Discriminant	30	960	Nearest Neighbors	91.8
2.	Ensemble Subspace Discriminant	30	960	Discriminant	97.5

TABLE VIII. PERFORMANCE COMPARISON OF THE PROPOSED MODEL WITH OTHER STATE-OF-THE-ART MODELS

Authors	Accuracy
(Almazaydeh, 2022) [38]	95.7%
D ² SE (Proposed Model)	97.5%

V. CONCLUSION

This paper proposes a robust deep learning app to identify the diabetic plants from VNPlant200 data set using fused deep neural network (DNN) model with Discriminant Subspace Ensemble. First, the features are extracted using DenseNet20 and the LDA is used to reduce the redundant information in this feature matrix and improve the discriminant ability of feature representation, and a nearest neighbors technique is used to produce a subspace ensemble for final diabetic therapeutic medicinal plant image classification. The proposed D²SE is deployed as a mobile application. The experiment results indicate that the proposed model achieved a reasonable recognition rate and provide a theoretical framework for further research and development of a medicinal plant classification system and positively contribute to the sustainability of human health. Our future research will focus on the study of the classification of medicinal plant leaves based on the leaf vein features and edge features.

Data availability: This work is based on VNPlant-200 dataset. It is publicly available in:

<https://github.com/kencoca/VietNam-Medicinal-Plant>

REFERENCES

- [1] International diabetic federation, "Facts and figures." Accessed: Nov. 18, 2023. [Online]. Available at: www.idf.org/aboutdiabetes/what-is-diabetes/facts-figures.html.
- [2] K. Schreck and M. F. Melzig, "Traditionally used plants in the treatment of diabetes mellitus: screening for uptake inhibition of glucose and fructose in the Caco2-cell model," *Frontiers in Pharmacology*, vol. 12, pp. 1-12, 2021.
- [3] I. Süntar, "Importance of ethnopharmacological studies in drug discovery: role of medicinal plants," *Phytochemistry Reviews*, vol. 19, no. 5, pp. 1199-1209, 2020.
- [4] F. Majolo, L. K. de Oliveira Becker Delwing, D. J. Marmitt, I. C. Bustamante-Filho, and M. I. Goettert, "Medicinal plants and bioactive natural compounds for cancer treatment: important advances for drug discovery," *Phytochemistry Letters*, vol. 31, pp. 196-207, 2018.
- [5] K. Ahmad, I. Choi, and Y. H. Lee, "Implications of skeletal muscle extracellular matrix remodeling in metabolic disorders: diabetes perspective," *International Journal of Molecular Sciences*, vol. 21, no. 11, pp. 3845, 2020.
- [6] M. Mathew and S. Subramanian, "In vitro evaluation of anti-Alzheimer effects of dry ginger (*Zingiber officinale* Roscoe) extract," *Indian Journal of Experimental Biology*, vol. 52, no. 6, pp. 606-612, 2014.
- [7] J. Martins and S. Brijesh, "Phytochemistry and pharmacology of anti-depressant medicinal plants: a review," *Biomedicine & Pharmacotherapy*, vol. 104, pp. 343-365, 2018.
- [8] M. Setorki, "Medicinal herbs with anti-depressant effects," *Journal of Hermed Pharmacology*, vol. 9, no. 4, pp. 309-317, 2020.
- [9] S. Sekhon-Loodu and H. P. V. Rupasinghe, "Evaluation of antioxidant, antidiabetic and antiobesity potential of selected traditional medicinal plants," *Frontiers in Nutrition*, vol. 6, pp. 1-11, 2019.
- [10] C. I. Chukwuma, M. G. Matsabisa, M. A. Ibrahim, O. L. Erukainure, M. H. Chabalala, and M. S. Islam, "Medicinal plants with concomitant anti-diabetic and anti-hypertensive effects as potential sources of dual acting therapies against diabetes and hypertension: a review," *Journal of Ethnopharmacology*, vol. 235, pp. 329-360, 2018.
- [11] Z. Rabiei, K. Solati, and H. Amini-Khoei, "Phytotherapy in treatment of Parkinson's disease: a review," *Pharmaceutical Biology*, vol. 57, no. 1, pp. 355-362, 2019.
- [12] B. Joseph and D. Jini, "Antidiabetic effects of *Momordica charantia* (bitter melon) and its medicinal potency," *Asian Pacific Journal of Tropical Disease*, vol. 3, no. 2, pp. 93-102, 2013.
- [13] M. Son, Y. Miura, and K. Yagasaki, "Mechanisms for antidiabetic effect of gingerol in cultured cells and obese diabetic model mice," *Cytotechnology*, vol. 67, no. 4, pp. 641-652, 2015.
- [14] B. Y. Lai, T. Y. Chen, S. H. Huang, T. F. Kuo, T. H. Chang, C. K. Yang, M. T. Yang, and C. L. T. Chang, "Bidens pilosa formulation improves blood homeostasis and β -cell function in men: a pilot study," *Evidence-Based Complementary and Alternative Medicine*, p. 832314, 2015.
- [15] Z. Rabiei, K. Solati, and H. Amini-Khoei, "Phytotherapy in treatment of Parkinson's disease: a review," *Pharmaceutical Biology*, vol. 57, no. 1, pp. 355-362, 2019.
- [16] C. J. Bailey, "The current drug treatment landscape for diabetes and perspectives for the future," *Clinical Pharmacology & Therapeutics*, vol. 98, no. 2, pp. 170-184, 2015.
- [17] F. Farzaei, M. R. Morovati, F. Farjadmand, and M. H. Farzaei, "A mechanistic review on medicinal plants used for diabetes mellitus in traditional persian medicine," *Journal of Evidence-Based Integrative Medicine*, vol. 22, no. 4, pp. 944-955, 2017.
- [18] A. B. Shori, "Screening of antidiabetic and antioxidant activities of medicinal plants," *Journal of Integrative Medicine*, vol. 13, no. 5, pp. 297-307, 2015.
- [19] M. Fatima, S. Hussain, M. Babar, M. Shahzad, and M.S. Zafar, "Curcumin: A Potential Therapeutic Agent for Human Health and Diseases—Current Status and Future Perspectives," *Pharmacological Benefits of Natural Agents*, pp. 278-297, 2023.
- [20] J. M. Isaza, S. M. Gutiérrez, and D. R. S. Escobar, "Phytotherapy in Mexico: a review," *Journal of Ethnopharmacology*, vol. 300, p. 113872, 2020.
- [21] R. Gupta and B. Gigras, "Medicinal plants and natural products in amelioration of arsenic toxicity: a short review," *Phytochemistry Reviews*, vol. 9, no. 2, pp. 23-33, 2010.
- [22] T. Galochkina, M. Ng Fuk Chong, L. Challali, S. Abbar, and C. Etchebest, "New insights into GluT1 mechanics during glucose transfer," *Scientific Reports*, vol. 9, no. 1, pp. 1-14, 2019.
- [23] M. Kuroda, Y. Mimaki, Y. Sashida, T. Mae, H. Kishida, T. Nishiyama, M. Tsukagawa, E. Konishi, K. Takahashi, T. Kawada, K. Nakagawa, and M. Kitahara, "Phenolics with PPAR- γ ligand-Binding activity obtained from licorice (*Glycyrrhiza uralensis* Roots) and ameliorative effects of glycyrrin

- on genetically diabetic KK-Ay mice," *Bioorganic & Medicinal Chemistry Letters*, vol. 13, no. 24, pp. 4267-4272, 2003.
- [24] F. Vlavecshi, D. Baron, I. A. Vlachogiannis, R. E. K. Macpherson, and E. Tsiani, "Carnosol increases skeletal muscle cell glucose uptake via AMPK-dependent GLUT4 glucose transporter translocation," *International Journal of Molecular Sciences*, vol. 19, no. 5, p. 1321, 2018.
- [25] G. P. Kamatou, C. Ssemakalu, and L. J. Shai, "Cassia abbreviata enhances glucose uptake and glucose transporter 4 translocation in C2C12 mouse skeletal muscle cells," *Journal of Evidence-Based Integrative Medicine*, vol. 26, pp. 1-11, 2021.
- [26] A. Altemimi, N. Lakhssassi, A. Baharlouei, D. G. Watson, and D. A. Lightfoot, "Phytochemicals: Extraction, isolation, and identification of bioactive compounds from plant extracts," *Plants*, vol. 6, no. 4, p. 42, 2017.
- [27] T. N. Quoc and V. T. Hoang, "Medicinal Plant identification in the wild by using CNN," in *2020 International Conference on Information and Communication Technology Convergence (ICTC)*, 2020, pp. 25-29.
- [28] C. Amuthalingeswaran, M. Sivakumar, P. Renuga, S. Alexpandi, J. Elamathi, and S. S. Hari, "Identification of medicinal plants and their usage by using deep learning," in *2019 3rd International conference on trends in electronics and informatics (ICOEI)*, 2019, pp. 886-890.
- [29] Y. A. Putri, E. C. Djalal, and R. Ilyas, "Identification of medicinal plant leaves using convolutional neural network," in *Journal of Physics: Conference Series*, vol. 1845, no. 1, p. 012026, 2021.
- [30] M. R. Dileep and P. N. Pournami, "Ayurveda: a deep learning approach for classification of medicinal plants," in *TENCON 2019-2019 IEEE Region 10 Conference (TENCON)*, 2019, pp. 321-325.
- [31] Y. Liu, Y. Li, Y. Zhao, and X. Na, "Image Classification and Recognition of Medicinal Plants Based on Convolutional Neural Network," in *2021 IEEE 21st International Conference on Communication Technology (ICCT)*, 2021, pp. 1128-1133.
- [32] S. Liu, W. Chen, and X. Dong, "Automatic classification of Chinese herbal based on deep learning method," in *2018 14th International conference on natural computation, fuzzy systems, and knowledge discovery (ICNC-FSKD)*, 2018, pp. 235-238.
- [33] A. Muneer and S. M. Fati, "Efficient and automated herbs classification approach based on shape and texture features using deep learning," *IEEE Access*, vol. 8, pp. 196747-196764, 2020.
- [34] G. Mukherjee, B. Tudu, and A. Chatterjee, "A convolutional neural network-driven computer vision system for identifying species and maturity stage of medicinal leaves: case studies with Neem, Tulsi, and Kalmegh leaves," *Soft Computing*, vol. 25, no. 22, pp. 14119-14138, 2021.
- [35] S. H. Lee, C. S. Chan, and P. Remagnino, "Multiorgan plant classification based on convolutional and recurrent neural networks," *IEEE Transactions on Image Processing*, vol. 27, no. 9, pp. 4287-4301, 2018.
- [36] V. Tiwari, R. C. Joshi, and M. K. Dutta, "Deep neural network for multi-class classification of medicinal plant leaves," *Expert Systems*, e13041, 2022.
- [37] M. Bhuiyan, M. Abdullahil-Oaphy, R. S. Khanam, and M. Islam, "MediNET: A deep learning approach to recognize Bangladeshi ordinary medicinal plants using CNN," in *Soft Computing Techniques and Applications*, 2021, pp. 371-380.
- [38] L. Almazydeh, R. Alsalamdeen, and K. Elleithy, "Herbal leaf recognition using mask-region convolutional neural network (mask r-CNN)," *Journal of Theoretical and Applied Information Technology*, vol. 100, no. 11.
- [39] Kirtikar, Basu, "Indian Medicinal Plants (4 Vols. Set)," *Periodical Experts Book Agency*, 2012, ISBN-13: 9788171360536.
- [40] NISC, "The Wealth of India: A Dictionary of Indian Raw Materials & Industrial Products," *National Institute of Science Communication, Council of Scientific & Industrial Research*, 2004, ISBN-13: 9788172362089.
- [41] Sivarajan, Indira Balachandran, "Ayurvedic Drugs and Their Plant Sources," *CBS Publishers & Distributors Pvt Ltd, India*, 2017, ISBN-13: 9788120408289.
- [42] Asolkar, Kakkar and Chakre, "Second Supplement to Glossary of Indian Medicinal Plants with Active Principles (Part - 1, A to K)," *National Institute of Science Communication*, 2010, ISBN-13: 9788120408289.
- [43] Chopra; Nayar; Chopra, "Glossary of Indian Medicinal Plants," *The Publications & Information Directorate, CSIR*, 2022, ISBN-13: 9788172361266.
- [44] Khare, C.P, "Indian Medicinal Plants: An Illustrated Dictionary," *Springer*, 2008, ISBN-13: 9780387706375.
- [45] CSIR, "The Treatise on Indian Medicinal Plants," *The Publications & Information Directorate, CSIR*, 2010, ISBN-13: 9788172363130.
- [46] Warriar, Nambiar, Ramankutty, "Indian Medicinal Plants: A Compendium of 500 Species (Vol. V)," *Orient Black Swan*, 2022, ISBN-13: 9788173717062.
- [47] C. H. Chen and K. W. Huang, "Digit Recognition Using Composite Features With Decision Tree Strategy," *International Journal of Interactive Multimedia and Artificial Intelligence*, vol. 8, no. 2, pp. 98-107, 2023. DOI: 10.9781/ijimai.2022.12.001.
- [48] V. Rajinikanth, S. Kadry, and P. Moreno-Ger, "ResNet18 Supported Inspection of Tuberculosis in Chest Radiographs With Integrated Deep, LBP, and DWT Features," *International Journal of Interactive Multimedia and Artificial Intelligence*, vol. 8, no. 2, pp. 38-46, 2023. DOI: 10.9781/ijimai.2023.05.004.
- [49] Z. H. Arif, M. Mahmoud, K. H. Abdulkareem, S. Kadry, M. A. Mohammed, M. N. Al-Mhiqani, A. S. Al-Waisy, and J. Nedoma, "Adaptive Deep Learning Detection Model for Multi-Foggy Images," *International Journal of Interactive Multimedia and Artificial Intelligence*, vol. 7, no. 7, pp. 26-37, 2022. DOI: 10.9781/ijimai.2022.11.008.



N. Sasikaladevi

Dr. N. Sasikaladevi received Ph. D. Degree in Computer Science in 2013. She has published more than 42 papers in reputed international journals and conferences including publications in SCI-Indexed Journals. She is a reviewer of more than a dozen of reputed journals including IEEE transactions on Services Computing and IEEE Journal of Internet of Things. Her significant research contribution includes the study of genus-2 and genus-3 Hyper elliptic curve to design the security system for power constraints devices and applications. Her research focus includes the design of machine learning strategies to solve Discrete Logarithm Problem. She published several books and chapters in reputed publisher including Prentice Hall of India, Lambert Academic Publisher, IGI Global, Springer and Science Direct. She has received fund from Department of Science and Technology, Government of India to carry out projects in the domain of Services computing and Security System. She has received young scientist award and women scientist award from DST, India. She is also involved in the security enriched payment system design as a part of Digital India Initiative.



A. Revathi

Dr. A. Revathi has obtained B.E (ECE), M.E (Communication Systems), and Ph. D (Speech Processing) from National Institute of Technology, Tiruchirappalli, Tamil Nadu, India in 1988, 1993 and 2009 respectively. She has been serving on the faculty of Electronics and Communication Engineering for 34 years and she is currently working as a Professor in the Department of ECE, SASTRA Deemed University, Thanjavur, India. She has published 60 papers in Reputed International journals and presented papers in more than 80 International Conferences. Her areas of interest include Speech processing, Signal processing, Image processing, Biometrics and Security, Communication Systems, Embedded Systems and Computer Networks.



Pradeepa Sampath

Dr. Pradeepa Sampath received B. Tech degree in Information Technology from Jayaram College of Engineering, Tirucirappalli, India in 2005. She obtained M.Tech. in computer science from PSNA College of Engineering and Technology, Tiruchirappalli in 2012. She received Ph. D. Degree in Computer Science in 2013 in the Department of Computer Science and Engineering, School of Computing, SASTRA Deemed University, India. She has published 15 papers in Reputed International journals and presented papers in more than 8 International Conferences. Her areas of interest include Text Mining, Machine Learning, Deep Learning, Big Data Analytics.

Vimal Shanmuganathan



Dr Vimal Shanmuganathan has obtained Ph.D degree in 2019 and completed the Post Doc in 2023. He is working in the Department of Artificial Intelligence & Data Science, Sri Eshwar College of Engineering, Coimbatore, Tamil Nadu (India). He has around Fifteen years of teaching experience, EMC certified Data science Associate and CCNA Certified professional too. He holds a Ph.D in Information and Communication Engineering from Anna University Chennai and he received Masters Degree from Anna University Coimbatore. His areas of interest include Game Modelling, Artificial Intelligence, Cognitive radio networks, Network security, Machine Learning and Big data Analytics. He is a Senior member in IEEE and holds membership in various professional bodies. He has hosted 22 special issues in IEE, Elsevier, Springer, Wiley and CMC tech science journals. He has served as Guest editor for SCI journals and edited 3 books in Scopus indexed also hosted 3 International conference indexed by Scopus. He is a Senior Member in IEEE.

Gaurav Dhiman



Dr. Gaurav Dhiman is a highly accomplished academician and researcher with an impressive track record of excellence in computer science. He holds a Ph.D. in Computer Engineering from Thapar Institute of Engineering & Technology, Patiala, and has also completed his Master Degree of Computer Applications from the same institute. Currently, he is serving as an Assistant Professor in the School of Sciences and Emerging Technologies, Jagat Guru Nanak Dev Punjab State Open University, Patiala. His research has been recognized at the highest level, as he has been named one of the world's top researchers by Stanford University, USA list of world's top 2% scientists prepared by Elsevier. He is the senior member of IEEE. He has also received accolades for his outstanding reviewer work from Knowledge-Based Systems (Elsevier). He has authored over 300 peer-reviewed research papers, all of which are indexed in SCI-SCIE, and 10 international books. He is currently serving as a guest editor for more than forty special issues in various peer-reviewed journals. He is an Editor-in-Chief of the International Journal of Modern Research (IJMORE), Co-Editor-in-Chief of the International Journal of Electronics and Communications Systems (IJECS) and International Journal of Ubiquitous Technology and Management (IJUTM). He is an Associate Editor of IEEE Transactions on Industrial Informatics, IET Software (Wiley), Expert Systems (Wiley), IEEE Systems, Man, and Cybernetics Magazine, Spatial Information Research (Springer), and more. He is also an Academic Editor of Computational and Mathematical Methods in Medicine (Hindawi), Scientific Programming (Hindawi), Mobile Information Systems (Hindawi), and Review Editor of Frontiers in Energy Research - Fuel Cells, Frontiers in High-Performance Computing - Parallel and Distributed Software, Frontiers in Artificial Intelligence - Pattern Recognition, and more. His research interests span a wide range of topics including Artificial Intelligence, Internet of Things, Machine-learning, Deep-learning, Single-, Multi-, Many-objective optimization (Bio-inspired, Evolutionary, and Quantum), Soft computing (Type-1 and Type-2 fuzzy sets), Power systems, and Change detection using remotely sensed high-resolution satellite data. He has published his research in various reputed journals, including IEEE, Elsevier, Springer, Wiley, Taylor and Francis, among others.